

PLAN VIEW - PANTRY COUNTERTOP
SCALE 1:20

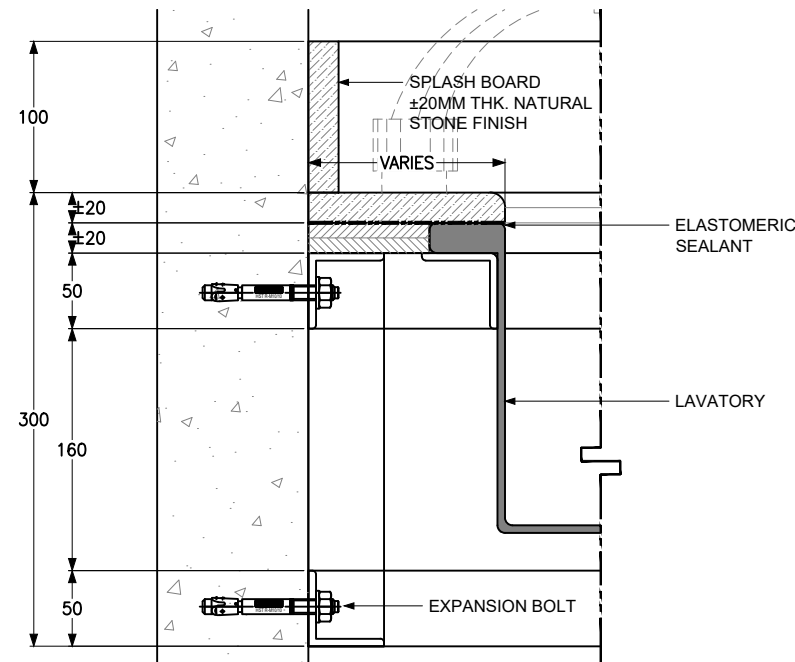

SPOT DETAIL 1
SCALE 1:5

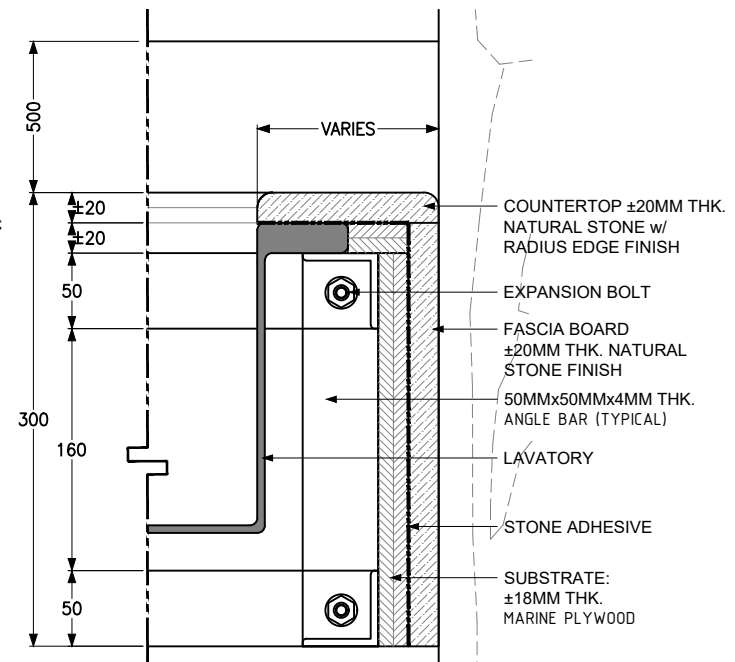

SPOT DETAIL 2
SCALE 1:5

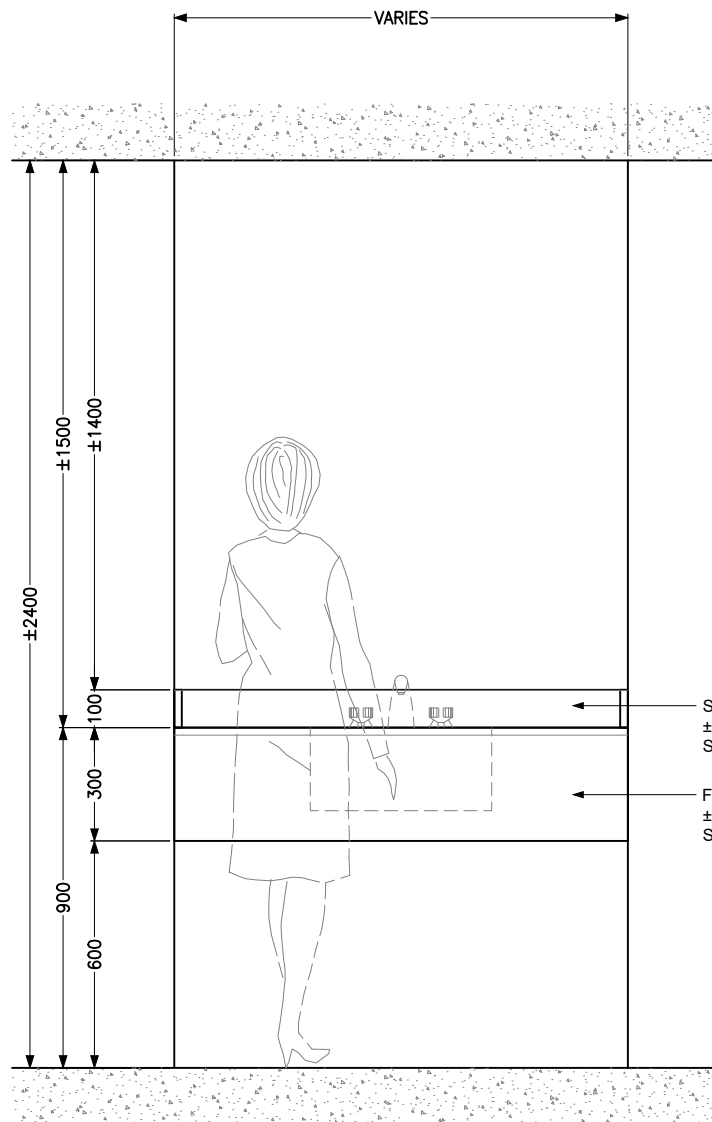

ELEVATION - PANTRY COUNTERTOP
SCALE 1:20

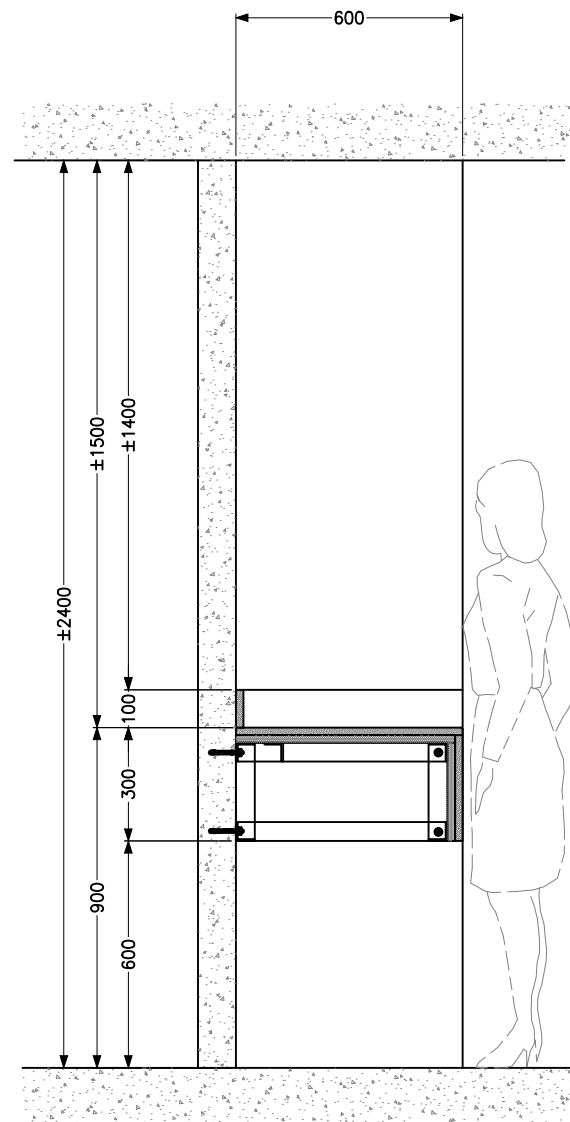

SECTION A - PANTRY COUNTERTOP
SCALE 1:20

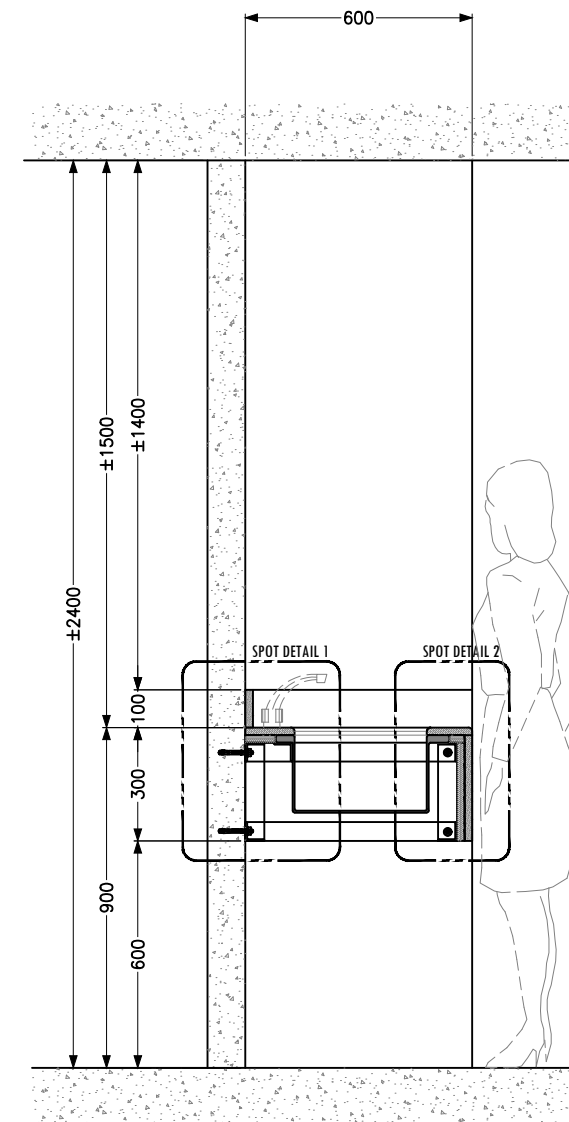

SECTION B - PANTRY COUNTERTOP
SCALE 1:20

EDUCATIONAL		BUSINESS	
FAIR USE OF THIS MATERIAL			
Credits: PANTRY COUNTERTOP by JBS, Visit us: storytosharedaily.com , Email us: storytosharedaily@gmail.com			
DRAWING TITLE:			
PANTRY COUNTERTOP			
DRAWING NO.:	JBS-C-10282021		
REVISION NO.:	00	REVISION DATE:	--
DRAWN BY:	JBS	RELEASED DATE:	OCTOBER 28, 2021
CHECKED BY:	JBS	SHEET NUMBER	001
APPROVED BY:	JBS		
SCALE: AS SHOWN		PAPER SIZE: A3	

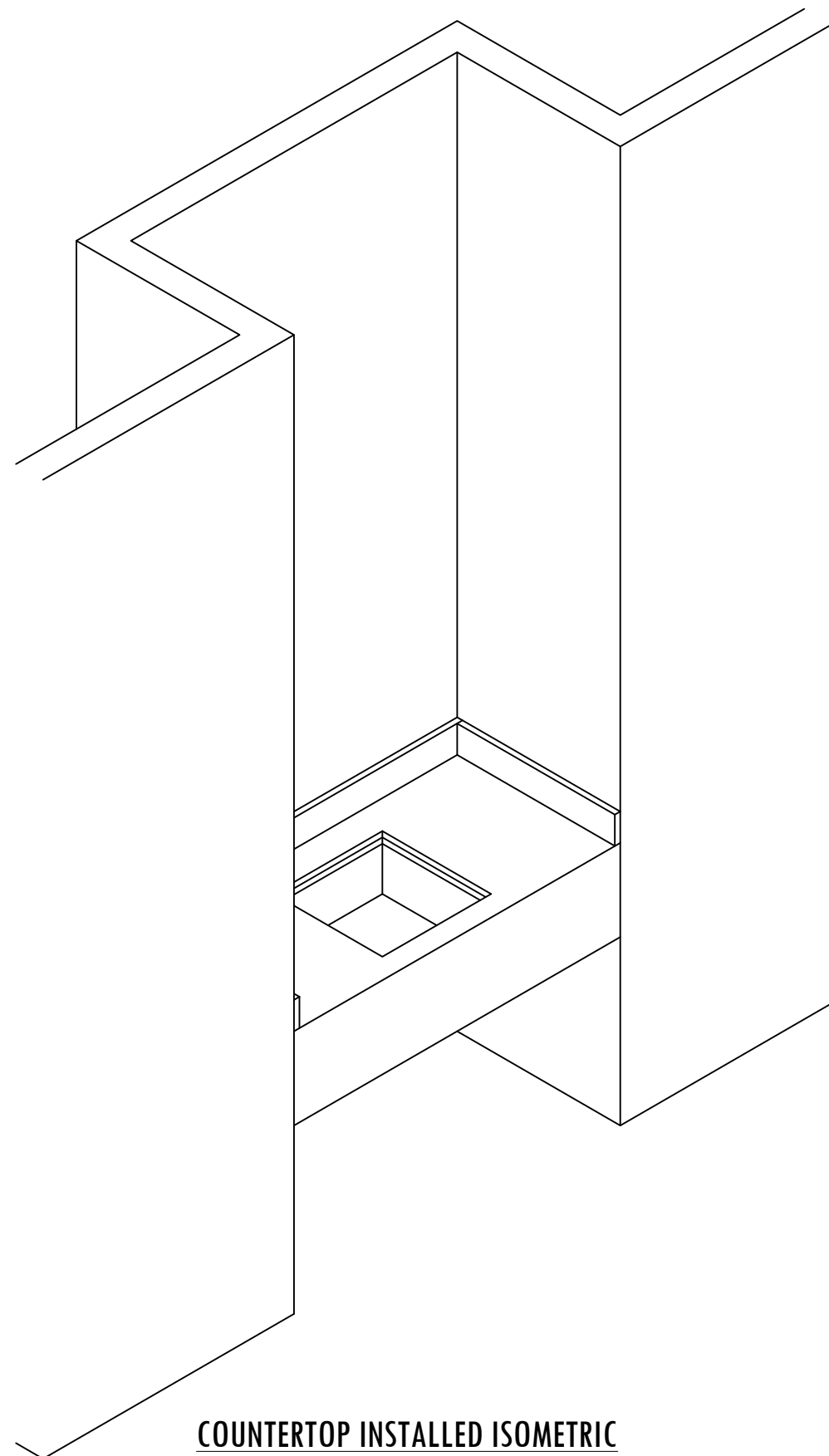

COUNTERTOP INSTALLED ISOMETRIC
SCALE 1:20

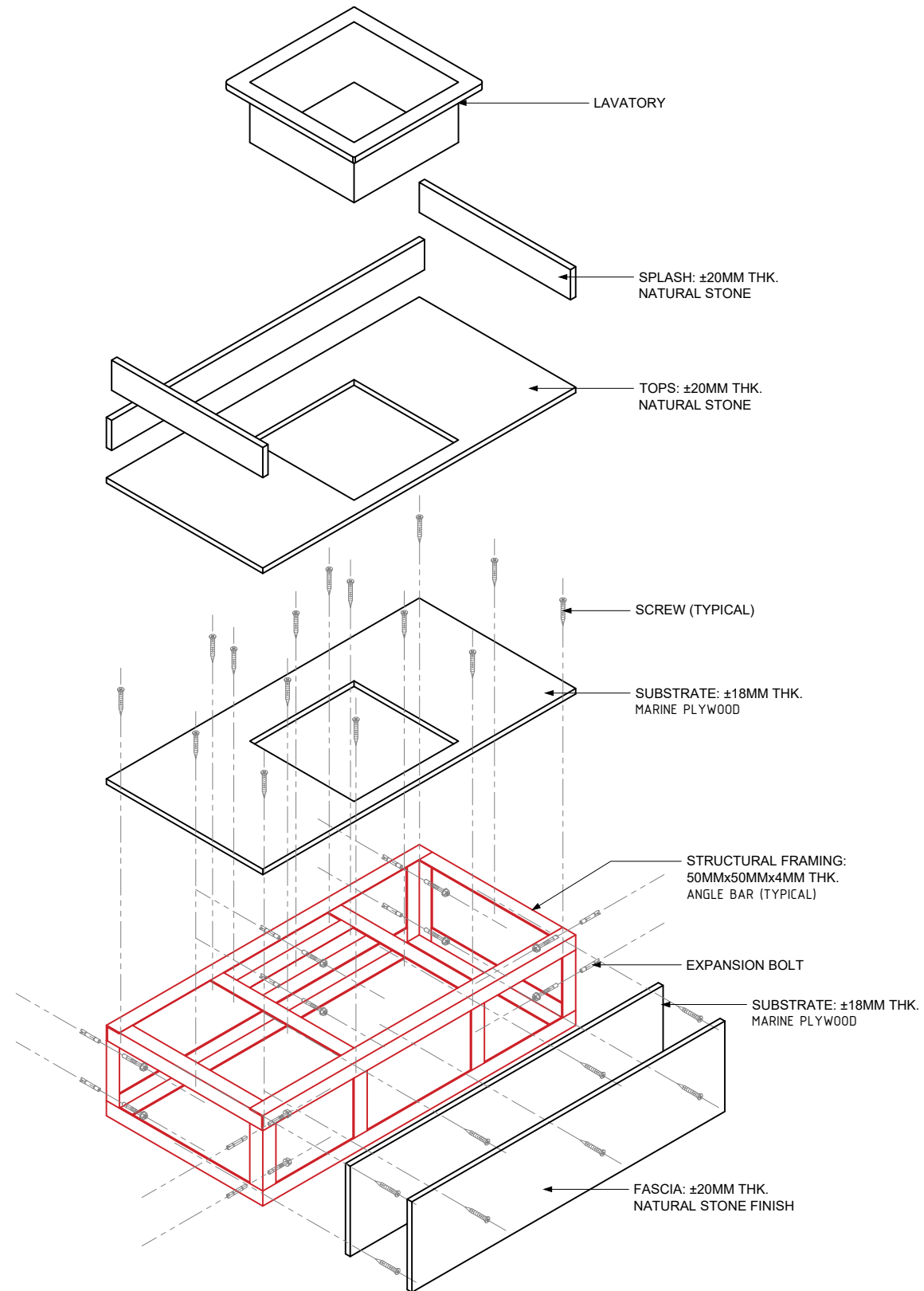

COUNTERTOP ASSEMBLY DRAWING
SCALE 1:20

EDUCATIONAL		BUSINESS	
FAIR USE OF THIS MATERIAL			
Credits: PANTRY COUNTERTOP by JBS, Visit us: storytosharedaily.com , Email us: storytosharedaily@gmail.com			
DRAWING TITLE:			
PANTRY COUNTERTOP (ASSEMBLY & ISOMETRIC DRAWING)			
DRAWING NO.:	JBS-C-10282021		
REVISION NO.:	00	REVISION DATE:	--
DRAWN BY:	JBS	RELEASED DATE:	OCTOBER 29, 2021
CHECKED BY:	JBS	SHEET NUMBER	002
APPROVED BY:	JBS		
SCALE:	1:20	PAPER SIZE:	A3